

SERIE GT

AISI-316

GRANDES VENTAJAS EN SU NÚCLEO EXTRAÍBLE

- Debido a su núcleo extraíble en el pernio alto, Vd. puede colocar los pernios en su taller, sin necesidad de realizar el montaje en la misma obra.
- Olvídense de usar pegamentos, ya que es un pernio-presión con juntas especiales de gran adherencia.
- Ensayos efectuados por nuestros técnicos en puertas de grandes dimensiones nos dan la razón.
- Gran movilidad en su núcleo extraíble, pues con una holgura de hasta 10 mm permite su colocación sin mover los pernios (ideal para paredes con desnivel).



* Bajo pedido para vidrio de 12 hasta 22 mm
* Otros acabados a consultar

PERNIO ALTO 160 x 50 mm

Medida máxima de la puerta: 2500 x 1100 mm

Peso máximo de la puerta: 75 kg

Acabados:

Vidrio 10 mm	Inox brillo Inox mate	5840 IB 5840 IM
Vidrio 12 mm	Inox brillo Inox mate	5840.12 IB 5840.12 IM

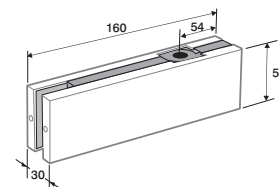
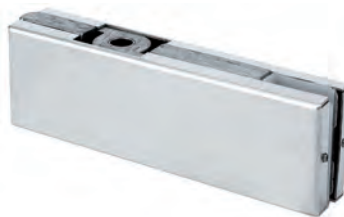

GT901
GT901V12
GT901D
GT901DV12

DESPLAZADO

Acabados:

Vidrio 10 mm	Inox brillo Inox mate	5844 IB 5844 IM
Vidrio 12 mm	Inox brillo Inox mate	5844.12 IB 5844.12 IM

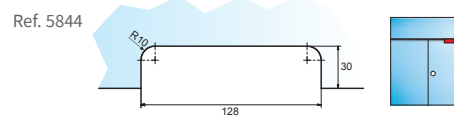
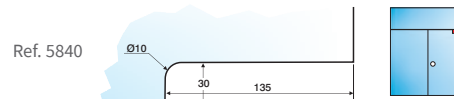

PERNIO BAJO REGLETA 160 x 50 mm

Medida máxima de la puerta: 2500 x 1100 mm

Peso máximo de la puerta: 75 kg

Acabados:

Vidrio 10 mm	Inox brillo Inox mate	5841 IB 5841 IM
Vidrio 12 mm	Inox brillo Inox mate	5841.12 IB 5841.12 IM

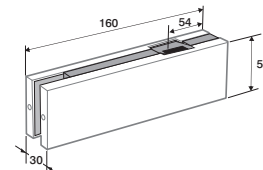

GT902R
GT902RV12
GT902RD
GT902RDV12

DESPLAZADO

Acabados:

Vidrio 10 mm	Inox brillo Inox mate	5845 IB 5845 IM
Vidrio 12 mm	Inox brillo Inox mate	5845.12 IB 5845.12 IM

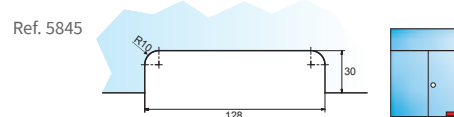
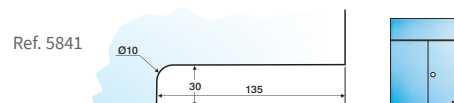

PERNIO BAJO CUADRADILLO FRANCÉS

160 x 50 mm

Medida máxima de la puerta: 2500 x 1100 mm

Peso máximo de la puerta: 75 kg

Acabados:

Vidrio 10 mm	Inox brillo	5842 IB
	Inox mate	5842 IM
Vidrio 12 mm	Inox brillo	5842.12 IB
	Inox mate	5842.12 IM

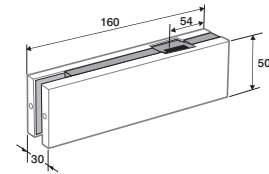

GT902C
GT902CV12
GT902CD
GT902CDV12

DESPLAZADO

Acabados:

Vidrio 10 mm	Inox brillo	5846 IB
	Inox mate	5846 IM
Vidrio 12 mm	Inox brillo	5846.12 IB
	Inox mate	5846.12 IM

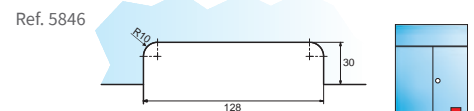
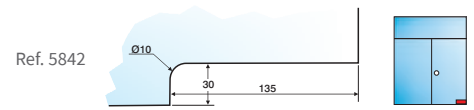

PERNIO BAJO EUROPEO

160 x 50 mm

Medida máxima de la puerta: 2500 x 1100 mm

Peso máximo de la puerta: 75 kg

Acabados:

Vidrio 10 mm	Inox brillo	5843 IB
	Inox mate	5843 IM
Vidrio 12 mm	Inox brillo	5843.12 IB
	Inox mate	5843.12 IM

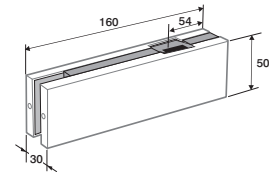

GT902E
GT902EV12
GT902ED
GT902EDV12

DESPLAZADO

Acabados:

Vidrio 10 mm	Inox brillo	5847 IB
	Inox mate	5847 IM
Vidrio 12 mm	Inox brillo	5847.12 IB
	Inox mate	5847.12 IM

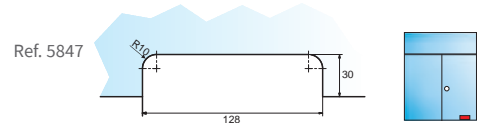
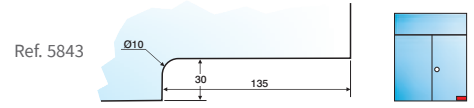

NÚCLEO EXTRAÍBLE PERNIO ALTO

M37

5895



NÚCLEO EXTRAÍBLE PERNIO BAJO REGLETA

M38

5896



NÚCLEO EXTRAÍBLE PERNIO BAJO CUADRADILLO FRANCÉS

M39

5897



NÚCLEO EXTRAÍBLE PERNIO BAJO EUROPEO

P14/1

5898





AISI-316

PUNTO DE GIRO

114 x 25 mm

Acabados:

Inox brillo	5868 IB
Inox mate	5868 IM

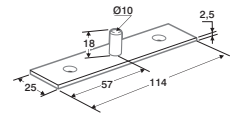

GT900

PUNTO DE GIRO MONTANTE

165 x 50 mm

Acabados:

Vidrio 10 mm	Inox brillo	5860 IB
	Inox mate	5860 IM
Vidrio 12 mm	Inox brillo	5860.12 IB
	Inox mate	5860.12 IM

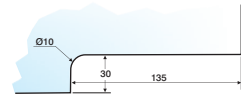
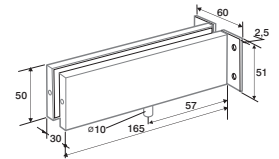

GT903
GT903V12

PUNTO DE GIRO MONTANTE DESPLAZADO

160 x 50 mm

Acabados:

Vidrio 10 mm	Inox brillo	5862 IB
	Inox mate	5862 IM
Vidrio 12 mm	Inox brillo	5862.12 IB
	Inox mate	5862.12 IM

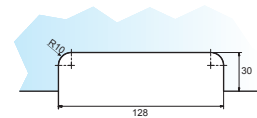
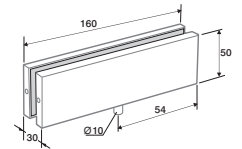

GT903D
GT903DV12

PUNTO DE GIRO LATERAL MONTANTE

212 x 105 mm

Acabados:

Vidrio 10 mm	Inox brillo	5865 IB
	Inox mate	5865 IM
Vidrio 12 mm	Inox brillo	5865.12 IB
	Inox mate	5865.12 IM

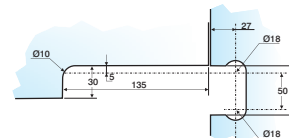
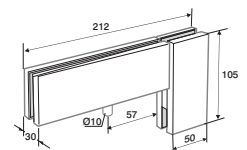

GT904
GT904V12

PUNTO DE GIRO LATERAL MONTANTE

ÁNGULO 90°

178 x 105 mm

Acabados:

Inox brillo	5866 IB
Inox mate	5866 IM

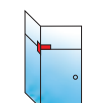
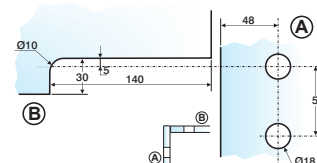
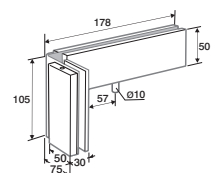

GT922

* Indicar mano

PUNTO DE GIRO TECHILLO

PARA Ref. 5840

Acabados:

Inox brillo	5869 IB
Inox mate	5869 IM

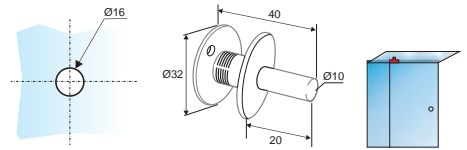

GT923

PUNTO DE GIRO LATERAL MONTANTE CON CONTRAFUERTE 212 x 105 mm

Acabados:

Inox brillo	5863 IB
Inox mate	5863 IM

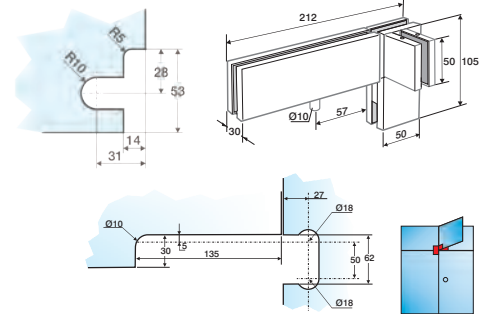

GT905

* Indicar mano

PUNTO DE GIRO MONTANTE DOBLE BATERÍA PUERTAS 320 x 50 mm

Acabados:

Inox brillo	5864 IB
Inox mate	5864 IM

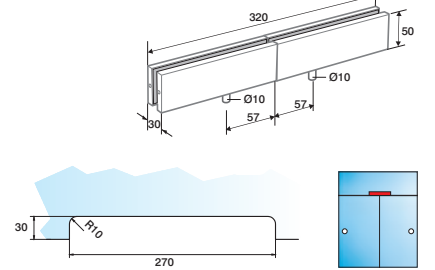

GT926

UNIÓN UNA LUNA 50 x 50 mm

Acabados:

Vidrio 10 mm	Inox brillo	5875 IB
	Inox mate	5875 IM
Vidrio 12 mm	Inox brillo	5875.12 IB
	Inox mate	5875.12 IM

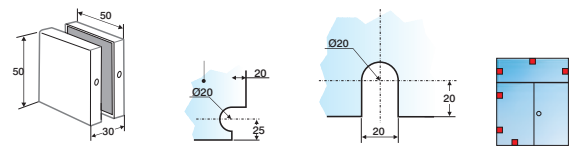

GT906
GT906V12

UNIÓN UNA LUNA VÉRTICES 50 x 50 mm

Acabados:

Inox brillo	5876 IB
Inox mate	5876 IM

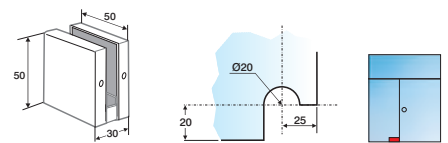

GT907

UNIÓN DOS LUNAS 105 x 50 mm

Acabados:

Inox brillo	5879 IB
Inox mate	5879 IM

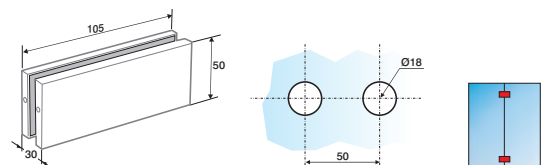

GT908



AISI-316

UNIÓN TRES LUNAS

105 x 105 mm

Acabados:

Vidrio 10 mm	Inox brillo	5884 IB
	Inox mate	5884 IM
Vidrio 12 mm	Inox brillo	5884.12 IB
	Inox mate	5884.12 IM

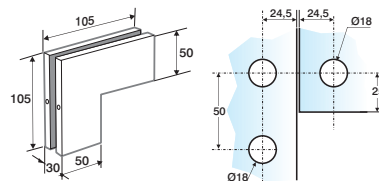

GT910
GT910V12



UNIÓN TRES LUNAS TOPE

105 x 105 mm

Acabados:

Inox brillo	5885 IB
Inox mate	5885 IM

* Indicar mano

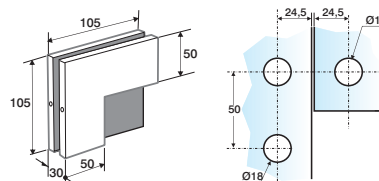

GT911



UNIÓN CUATRO LUNAS

105 x 105 mm

Acabados:

Inox brillo	5886 IB
Inox mate	5886 IM

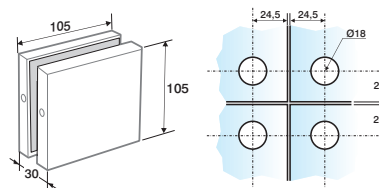

GT912



UNIÓN DOS LUNAS TOPE

105 x 50 mm

Acabados:

Inox brillo	5880 IB
Inox mate	5880 IM

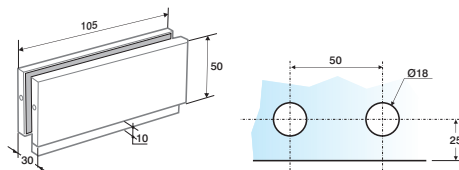

GT913



UNIÓN TRES LUNAS CON CONTRAFUERTE

105 x 50 mm

Acabados:

Inox brillo	5883 IB
Inox mate	5883 IM

* Indicar mano

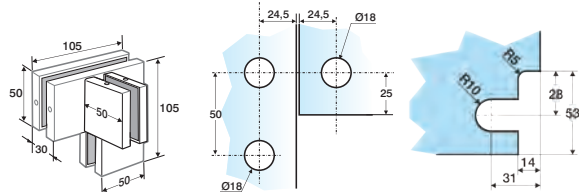

GT914



UNIÓN TRES LUNAS TOPE CON CONTRAFUERTE

105 x 105 mm

Acabados:

Inox brillo	5887 IB
Inox mate	5887 IM

* Indicar mano

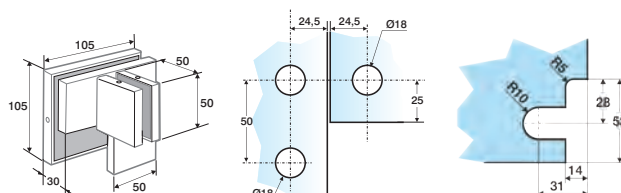

GT915

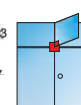

**UNIÓN DOS LUNAS
CON CONTRAFUERTE
105 x 50 mm**

GT916

Acabados:

Inox brillo	5881 IB
Inox mate	5881 IM

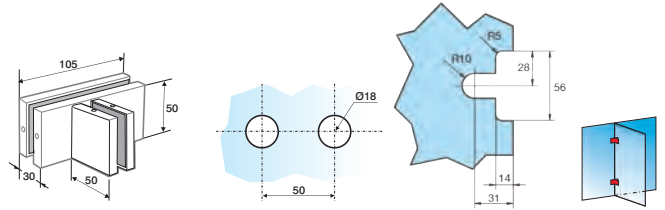

**UNIÓN DOS LUNAS
ÁNGULO 90°**

GT917

Acabados:

Inox brillo	5890 IB
Inox mate	5890 IM

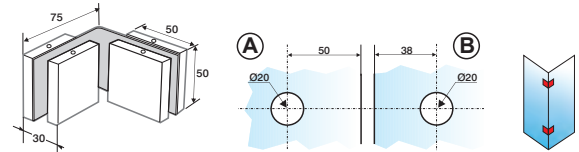

**UNIÓN DOS LUNAS
ÁNGULO 90° SUELO/TECHO**

GT918

Acabados:

Inox brillo	5891 IB
Inox mate	5891 IM

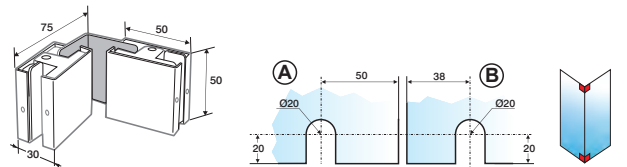

**UNIÓN TRES LUNAS
ÁNGULO 90°**

GT919

Acabados:

Inox brillo	5882 IB
Inox mate	5882 IM

* Indicar mano

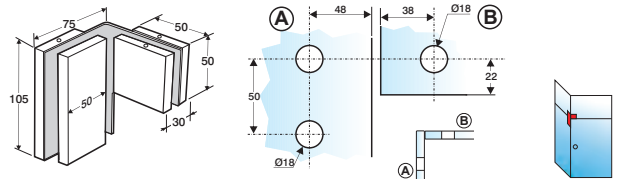

**UNIÓN TRES LUNAS TOPE
ÁNGULO 90°**

GT920

Acabados:

Inox brillo	5888 IB
Inox mate	5888 IM

* Indicar mano

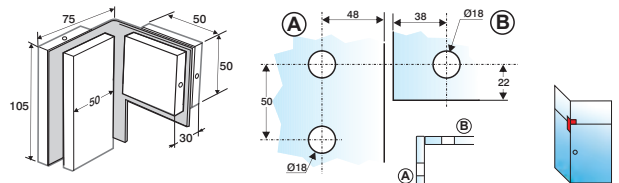

**UNIÓN CUATRO LUNAS
ÁNGULO 90°**

GT921

Acabados:

Inox brillo	5889 IB
Inox mate	5889 IM

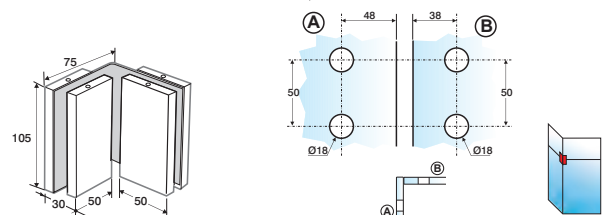



AISI-316

UNIÓN DOS LUNAS VERTICAL

105 x 50 mm

Acabados:

Inox brillo	5878 IB
Inox mate	5878 IM

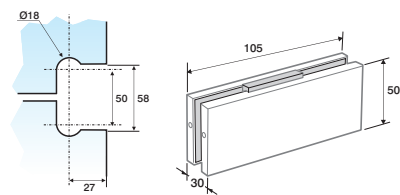

GT924



UNIÓN DOS LUNAS SIN ANCLAJE INTERIOR

50 x 50 mm

Acabados:

Inox brillo	5872 IB
Inox mate	5872 IM

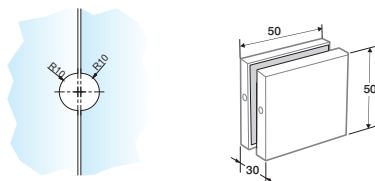

GT925

